

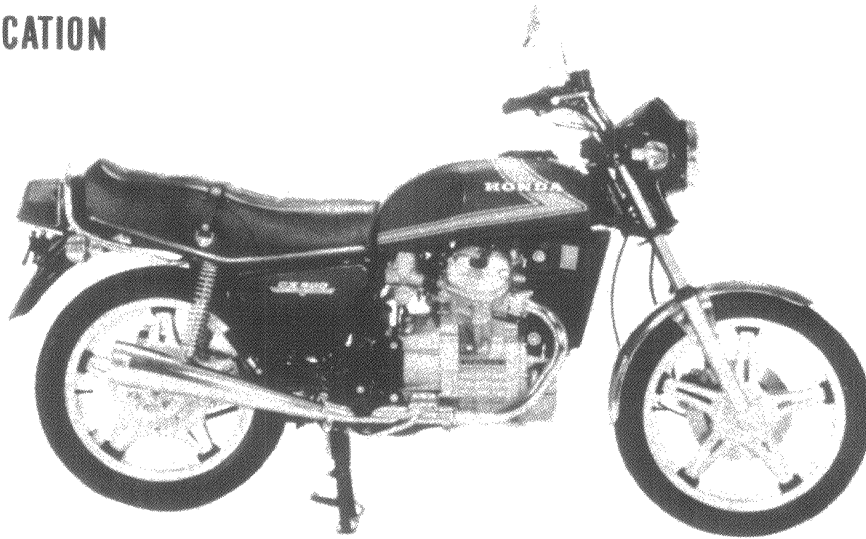

MODEL IDENTIFICATION



BEGINNING WITH F/N 2000001

The frame serial number is stamped on the right side of the steering head.

The legal vehicle identification number is on the left side of the steering head.

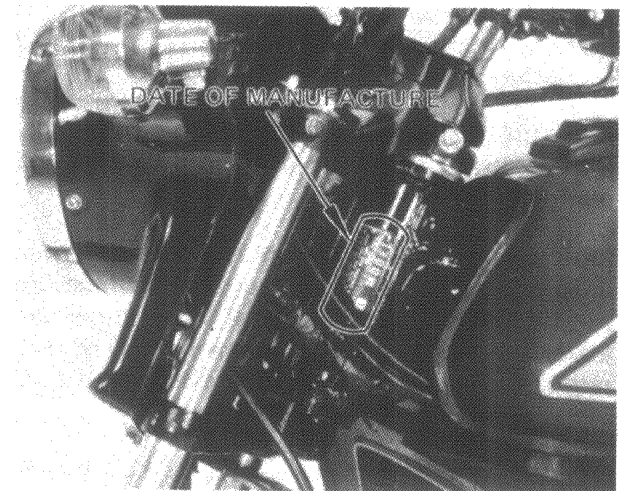
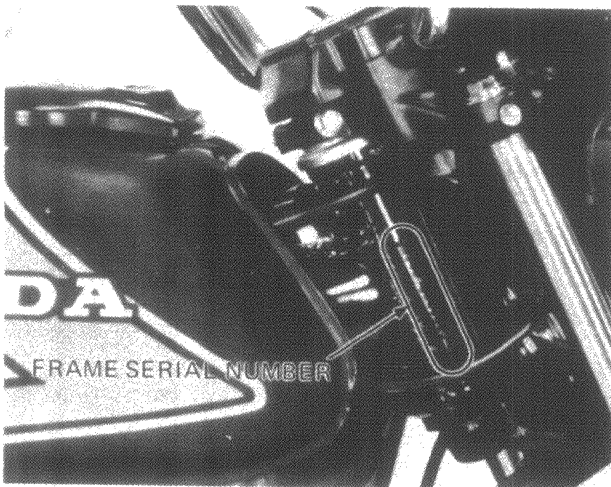

The engine serial number is stamped on the lower left side of the engine case.

The carburetor identification number is on the left side of the carburetor body.

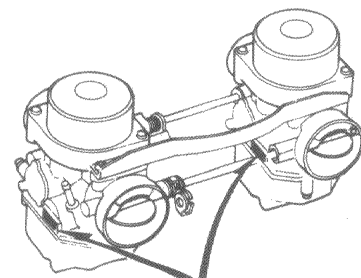
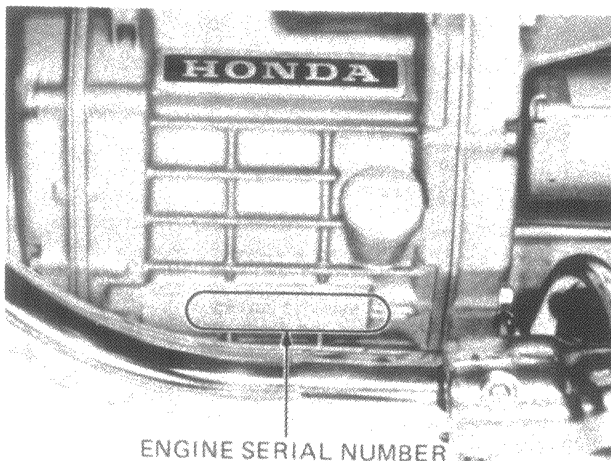

IDENTIFICATION NUMBER

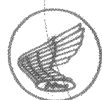

1. GENERAL INFORMATION

GENERAL SAFETY	1-1	WIRING DIAGRAM	1-6
SERVICE RULES	1-1	CABLE & HARNESS ROUTING	1-7
SPECIFICATIONS	1-2	EMISSION CONTROL SYSTEM	1-8
TORQUE VALUES	1-4	EMISSION CONTROL INFORMATION LABEL	1-9
SPECIAL TOOLS/COMMON TOOLS	1-5	MAINTENANCE SCHEDULE	1-10

GENERAL SAFETY

WARNING

If the engine must be running to do some work, make sure the area is well-ventilated. Never run the engine in a closed area. The exhaust contains poisonous carbon monoxide gas.

WARNING

Gasoline is extremely flammable and is explosive under certain conditions. Do not smoke or allow flames or sparks in your working area.

WARNING

- *The battery electrolyte contains sulfuric acid. Protect your eyes, skin and clothing. In case of contact, flush thoroughly with water and call a doctor if your eyes were exposed.*

WARNING

- *The battery generates hydrogen gas which can be highly explosive. Do not smoke or allow flames or sparks near the battery, especially while charging it.*

SERVICE RULES

1. Use genuine HONDA or HONDA-recommended parts and lubricants or their equivalent. Parts that do not meet HONDA's design specifications may damage the motorcycle.
2. Use the special tools designed for this product.
3. Install new gaskets, O-rings, cotter pins, lock plates, etc. when reassembling.
4. When torquing bolts or nuts, begin with larger-diameter or inner bolt first, and tighten to the specified torque diagonally, unless a particular sequence is specified.
5. Clean parts in cleaning solvent upon disassembly. Lubricate any sliding surfaces before reassembly.
6. After reassembly, check all parts for proper installation and operation.
7. Use only metric tools when servicing this motorcycle. Metric bolts, nuts, and screws are not interchangeable with English fasteners. The use of incorrect tools and fasteners may damage the motorcycle.

SPECIFICATIONS

	Item	Metric	English	
DIMENSIONS	Overall length	2,185 mm	86.0 in	
	Overall width	865 mm	34.1 in	
	Overall height	1,175 mm	46.3 in	
	Wheel base	1,455 mm	57.3 in	
	Seat height	810 mm	31.9 in	
	Foot peg height	335 mm	13.2 in	
	Ground clearance	150 mm	5.9 in	
	Dry weight	200 kg	441 lbs	
FRAME	Type	Diamond		
	F. suspension and travel	Telescopic fork, 139.5 mm (5.5 in)		
	R. suspension and travel	Swing arm, 85 mm (3.3 in)		
	F. tire size and air pressure	3.25S19-4PR 1.75 kg/cm ² (24 psi)		
	R. tire size and air pressure	3.75S18-4PR 2.0/2.5 kg/cm ² (28/36 psi)		
	F. brake	Disc brake		
	R. brake	Internal expanding shoes		
	Fuel capacity	17 lit.	4.5 US gal 3.7 Imp gal	
	Fuel reserve capacity	3.5 lit.	0.9 US gal 0.8 Imp gal	
	Caster angle	63° 30'		
	Trail length	100 mm	3.9 in	
	Front fork oil capacity	135 cc (to fill if dry)	4.7 oz	
ENGINE	Type	Liquid cooled 4 stroke OHV engine		
	Cylinder arrangement	2 cylinder transverse V		
	Bore and stroke	78 x 52 mm	3.071 x 2.047 in	
	Displacement	496 cc	30.3 cu. in	
	Compression ratio	10:1		
	Valve train	Chain driven camshaft and push rod		
	Oil capacity	3.0 lit.	3.2 US qt 2.6 Imp qt	
	Lubrication system	Forced pressure and wet sump		
	Cooling system capacity	2.0 lit.	0.52 US gal	
	Cylinder compression	12 kg/cm ²	171 psi	
	Intake valve	Opens	6° BTDC (at 1 mm lift), 75° BTDC (at 0 lift)	
		Closes	46° ABDC (at 1 mm lift), 115° ABDC (at 0 lift)	
	Exhaust valve	Opens	46° BBDC (at 1 mm lift), 111° BBDC (at 0 lift)	
		Closes	6° ATDC (at 1 mm lift), 71° ATDC (at 0 lift)	
	Valve clearance	IN.	0.08 mm	0.003 in
		EX.	0.10 mm	0.004 in
Idle speed	1,100 ± 100 rpm			
CARBURETION	Carburetor type	CV type, 35 mm (1.38 in) venturi bore		
	Setting number	VB26A		
	Pilot screw initial setting	See page 4-10		
	Float level	15.5 mm	0.61 in	



	Item		Metric	English	
DRIVE TRAIN	Clutch		Wet, multi-plate		
	Transmission		5-speed, constant mesh		
	Primary reduction ratio		2.242 (74/33)		
	Gear ratio I		2.733 (41/15)		
	Gear ratio II		1.850 (37/20)		
	Gear ratio III		1.416 (34/24)		
	Gear ratio IV		1.148 (31/27)		
	Gear ratio V		0.931 (27/29)		
	Final reduction ratio		3.091 (34/11)		
	Gear shift pattern		Left foot operated return system		
	Final gear oil capacity		170 ± 10 cc	5.7 ± 0.3 US oz	
ELECTRICAL	Ignition		C.D.I.		
	Ignition advance	"F" mark	15° BTDC		
		Maximum advance	37° ± 3° BTDC		
		RPM from "F" to max. advance	1,750 ~ 6,000 rpm		
	Starting system		Starter motor		
	Alternator		Three phase A.C.G. 12 V 0.17 kw/5,000 rpm		
	Battery capacity		12 V - 14 AH		
	Spark plug (STD)	USA model	ND X24ES-U NGK D8EA		
		Canadian model	ND X24ESR-U NGK DR8ES-L		
Spark plug gap		0.6 ~ 0.7 mm	0.024 ~ 0.028 in.		
LIGHTS	Headlight (low/high beam)		40/50 watt		
	Tail/stop light		8/27 watt 3/32 cp SAE No. 1157		
	Turn signal light	Front	23/23 watt 32/32 cp SAE No.	FRONT 1034	
		Rear		REAR 1073	
	Meter light	Speedometer	3.4 watt 2 cp SAE No. 57		
		Tachometer			
	Neutral indicator light		3.4 watt 2 cp SAE No. 57		
	Turn signal indicator light		3.4 watt 2 cp SAE No. 57		
	High beam indicator light		3.4 watt 2 cp SAE No. 57		
	Oil pressure warning light		3.4 watt 2 cp SAE No. 57		
Parking light		8 watt 3 cp SAE No. 1034			

**GENERAL INFORMATION****TORQUE VALUES**

<ENGINE>

Item	Q'ty	Thread Dia. (mm)	Torque Values	
			kg-m	ft-lb
Crankshaft cap	7	8	2.0 - 2.4	14 - 17
Connecting rod cap	4	8	2.8 - 3.2	20 - 23
Cylinder head	8	12	5.0 - 5.5	36 - 40
Valve adjusting nut	8	6	1.5 - 1.8	11 - 13
Flywheel	1	12	8.0 -10.0	58 - 72
Clutch center	1	20	8.0 -10.0	58 - 72
Primary drive gear	1	12	8.0 - 9.5	58 - 69
Starting clutch outer	3	8	1.8 - 2.5	13 - 18
Cooling fan	1	8	2.0 - 2.5	14 - 18
Cam sprocket boss	1	20	8.0 -10.0	58 - 72
Cam sprocket	2	7	1.6 - 2.0	12 - 14
Change pedal	1	6	1.0 - 1.4	7 - 10
Radiator drain bolt	1	12	0.15- 0.30	1.1- 2.2

<FRAME>

Item	Q'ty	Thread Dia. (mm)	Torque Values	
			kg-m	ft-lb
Steering stem nut	1	24	9.0 -12.0	65 - 87
Handlebar top bridge	2	7	0.9 - 1.3	7 - 9
Handlebar lock	2	6	1.0 - 1.4	7 - 10
Handlebar holder	4	8	2.5 - 3.0	18 - 22
Front fork bottom bridge	2	8	1.8 - 2.5	13 - 18
Front and rear axles	1	14	5.5 - 6.5	40 - 47
Front axle holder	4	8	1.8 - 2.5	13 - 18
Engine hanger bolt	4	10	3.5 - 4.5	25 - 33
Engine hanger bolt	1	12	6.0 - 7.0	43 - 51
Final drive flange nut	3	10	3.5 - 4.5	25 - 33
Rear brake torque link	1	8	1.5 - 2.3	11 - 17
Rear shock absorber	4	10	3.0 - 4.0	22 - 29
Foot peg	2	10	3.0 - 4.0	22 - 29
Swing arm pivot nut	1	23	8.0 -12.0	58 - 87
Front brake disc	5	8	2.7 - 3.3	20 - 24
Gear case rear fork	3	10	3.5 - 4.5	25 - 33
Swing arm pivot bolt	1	23	0.8 - 1.2	6 - 9
Front caliper	2	10	3.0 - 4.0	22 - 29

Torque specifications listed above are important tightening points. Others should be torqued to standard torques below.

● STANDARD TORQUE VALUES

Item	Torque Values kg-m (ft-lb)	Item	Torque Values kg-m (ft-lb)
5 mm bolt and nut	0.45-0.6 (3- 4)	5 mm screw	0.35-0.5 (3- 4)
6 mm bolt and nut	0.8 -1.2 (6- 9)	6 mm screw	0.7 -1.1 (5- 8)
8 mm bolt and nut	1.8 -2.5 (13-18)	6 mm flange bolt and nut	1.0 -1.4 (7-10)
10 mm bolt and nut	3.0 -4.0 (22-29)	8 mm flange bolt and nut	2.0 -3.0 (14-21)
12 mm bolt and nut	5.0 -6.0 (36-43)	10 mm flange bolt and nut	3.0 -4.0 (22-29)



SPECIAL TOOLS / COMMON TOOLS

● SPECIAL TOOLS

Tool Name	Tool No.	Appropriation List (Common Tool — Special Tool)	
Torx driver bit	07703-0010100	Local purchase item T40 torx bit or socket	
Piston slider	07755-0010000	Local purchase item ratchet type	
* Socket wrench (27 x 17 mm)	07907-4150000		
Final retainer wrench	07910-3710100		
* Retainer B wrench	07910-4150000		
Snap ring pliers	07914-3230001		
Hollow set wrench (6 mm)	07917-3230000	Local purchase item	
Socket bit (10 mm)	07917-3710000	Local purchase item	
* Clutch center holder	07923-4150000		
* Gear holder	07924-4150000		
* Crank cap puller	07935-4150000		
Bearing remover head (20 mm)	07936-3710600		
(Bearing remover handle)	(07936-3710100)		
(Bearing remover weight)	(07936-3710200)		
Bearing remover head	07936-3710600		
* Pivot bearing outer remover	07936-4150000		
* Piston remover	07941-4150000		
* Valve guide driver attachment	07943-4150000		
Ball race driver (BOTTOM)	07945-3330300		
* Crank cap driver	07945-4150100		
* Mechanical seal driver attachment	07945-4150200		
* Mechanical seal pilot	07945-4150301		
Ball race driver (TOP)	07946-3290000	Ball race remover/installer	07946-3710400
Steering stem driver	07946-3710600		
Ball race remover	07953-3330000	Ball race/cone driver	07946-3710600
* Ring gear Dis/Assembly tool set	07965-4150000		
* (Ring gear center guide)	(07965-4150100)		
* (Dis/Assembly tool A)	(07965-4150200)		
(Dis/Assembly tool B)	(07965-3710200)		
(Dis/Assembly tool C)	(07965-3710300)		
* Main bearing Dis/Assembly tool	07973-4150000		
Valve guide reamer (6.6 mm)	07984-6110000		
* Preload inspection tool	07998-4150000		
* Inspection plug	07999-4150000		
Special tool case	07797-2920300		
Vacuum gauge tester	07404-0020000		
(Vacuum gauge attachment)	(07510-3000100)		
* Tire lever set (for comstar wheel)	07772-0020000		
(Tire lever)	(07772-0020100)		
(Rim protector)	(07772-0020200)		

- The tools asterisked (*) are included in the "SPECIAL TOOL SET B 07900-4150101" and these are new for CX500.
- The tools starred (★) are designed for comstar wheels.

● COMMON TOOLS

Tool Name	Tool No.	Appropriation List (Common Tool — Special Tool)	
Float level gauge	07401-0010000		
Pin spanner	07702-0010000	←	
Tappet adjusting wrench (10 x 12 mm)	07708-0030200	Pin spanner (46 mm)	07902-2400000
Tappet adjusting (B)	07708-0030400	Tappet adjusting wrench set	07908-3640000
Retainer wrench B	07710-0010200	(Tappet adjusting wrench (10 mm)	07908-3640100)
Retainer wrench body	07710-0010401	(Tappet adjusting (A)	07908-3290100)
Lock nut wrench socket (26 x 29 mm)	07716-0020201	Retainer wrench	07910-3230101
Lock nut wrench socket (30 x 32 mm)	07716-0020400	*	
Extension bar & handle	07716-0020500	* Local purchase item	
Flywheel & rotor puller	07733-0010000	* Local purchase item	
Rotor puller	07733-0020000	Flywheel puller	07933-0010000
Valve guide remover (6.6 mm)	07742-0010200	Rotor puller	07933-2000000
Pin driver (3.5 mm)	07744-0010300	Valve guide driver	07942-6110000
Bearing driver outer (42 x 47 mm)	07746-0010300	Pin driver (3.5 mm)	07944-6340100
Bearing driver outer (52 x 55 mm)	07746-0010400	Bearing driver	07945-3330100
Bearing driver pilot (15 mm)	07746-0040300	Bearing driver	07946-3710200
Bearing driver pilot (20 mm)	07746-0040500	* Not applicable to special tool	
Bearing driver pilot (22 mm)	07746-0041000	* Not applicable to special tool	
Bearing driver pilot (25 mm)	07746-0040600	* Not applicable to special tool	
Bearing driver pilot (30 mm)	07746-0040700	* Not applicable to special tool	
Front fork oil seal driver body	07747-0010100	* Not applicable to special tool	
Front fork oil seal attachment (D)	07747-0010500	Fork seal driver	07947-3330000
Bearing driver handle (A)	07749-0010000	Driver handle attachment	
Valve spring compressor	07757-0010000	(Not to be used with common tools)	07949-6110000
Rear shock absorber compressor	07759-3290001	Valve spring compressor	07957-3290001

- The tools asterisked (*) indicate those which are not found in special tools.
- See the "NEW MOTORCYCLE COMMON TOOL LIST" at the back of this manual.

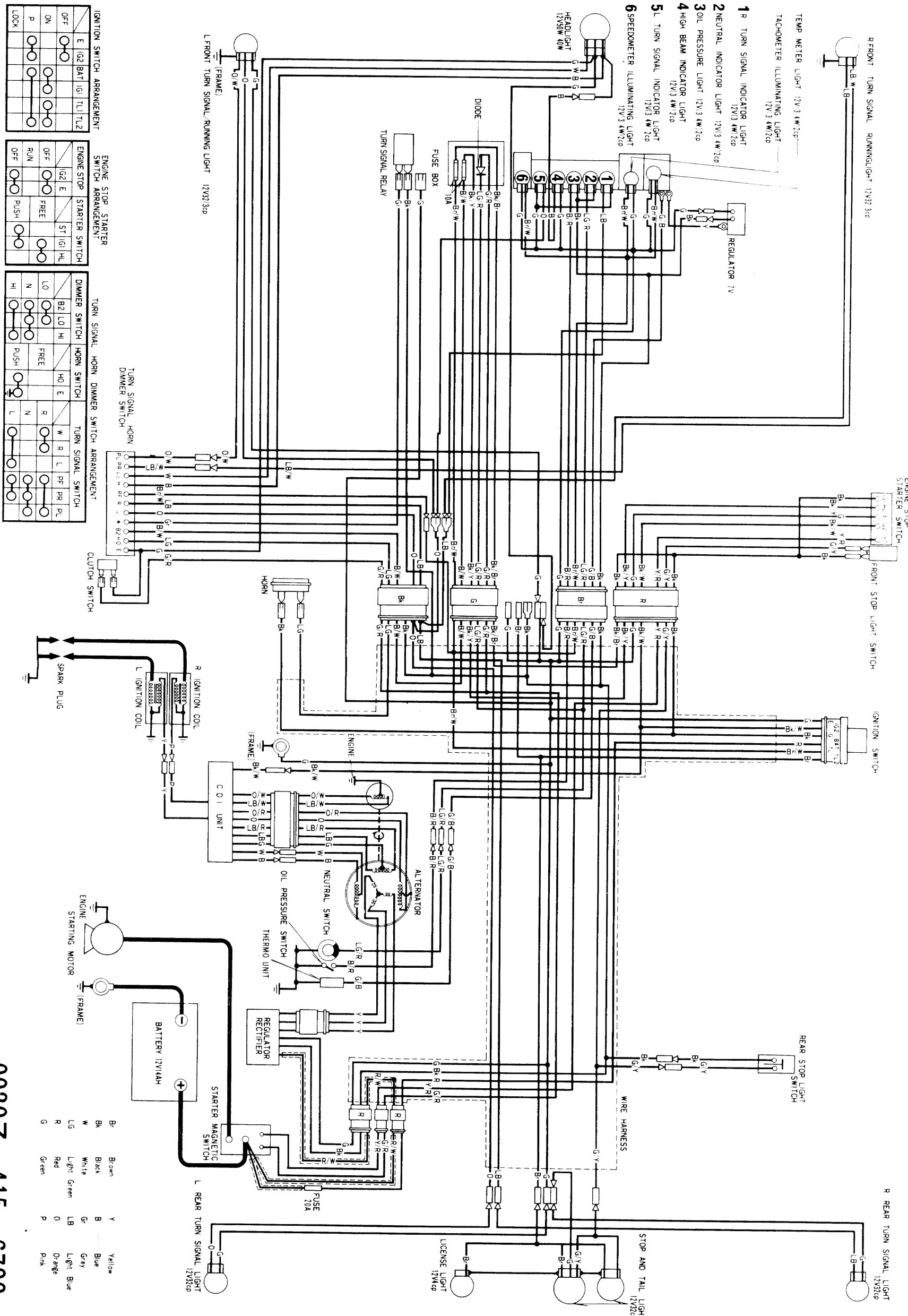

IGNITION SWITCH ARRANGEMENT

OFF	E	IG2	BAT	IG1	ILL	ILL2
ON	○	○	○	○	○	○
P	○	○	○	○	○	○
LOCK	○	○	○	○	○	○

ENGINE STOP STARTER SWITCH ARRANGEMENT

OFF	IG2	E	STARTER	ST	IG1	H/L
FREE	○	○	○	○	○	○
PUSH	○	○	○	○	○	○

TURN SIGNAL HORN DIMMER SWITCH ARRANGEMENT

HI	B2	LO	HI	HO	E	TURN SIGNAL	TURN SIGNAL
○	○	○	○	○	○	○	○
○	○	○	○	○	○	○	○
○	○	○	○	○	○	○	○

0030Z—415—6700

CABLE & HARNESS ROUTING

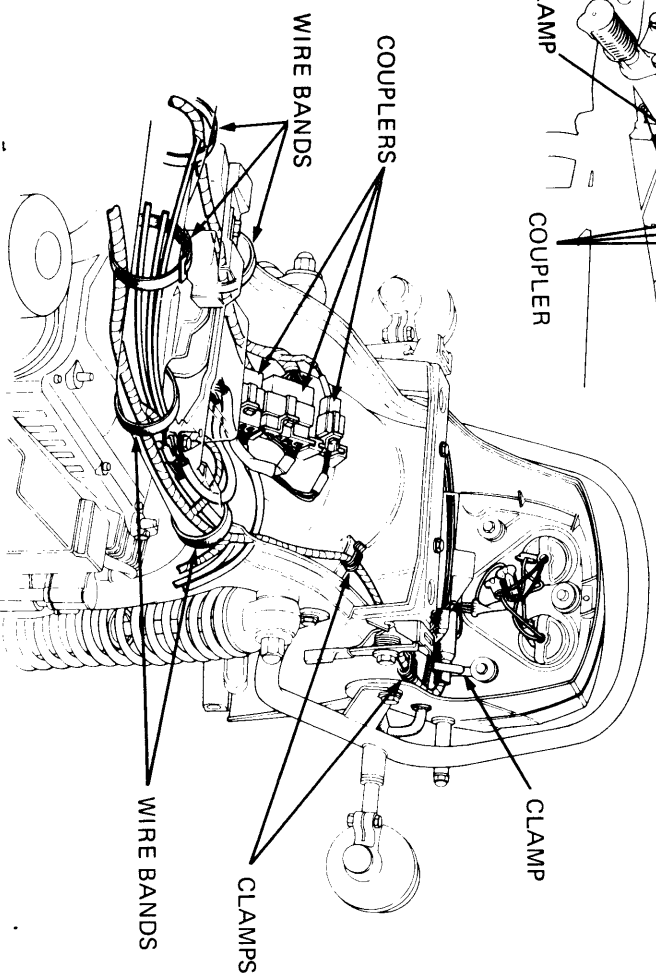
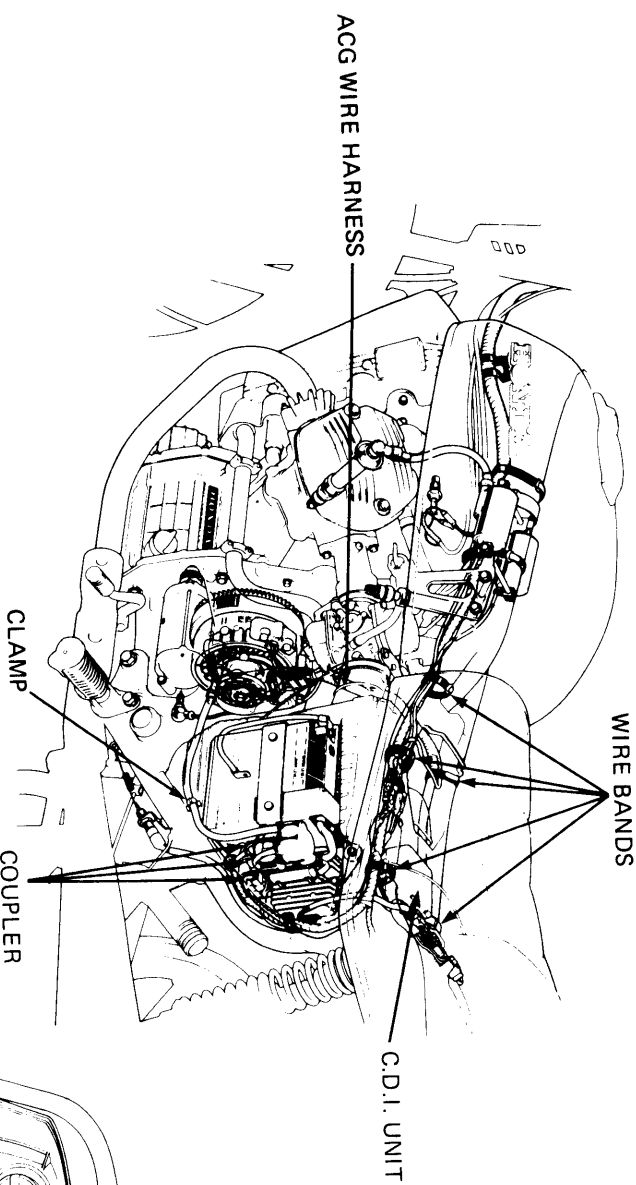
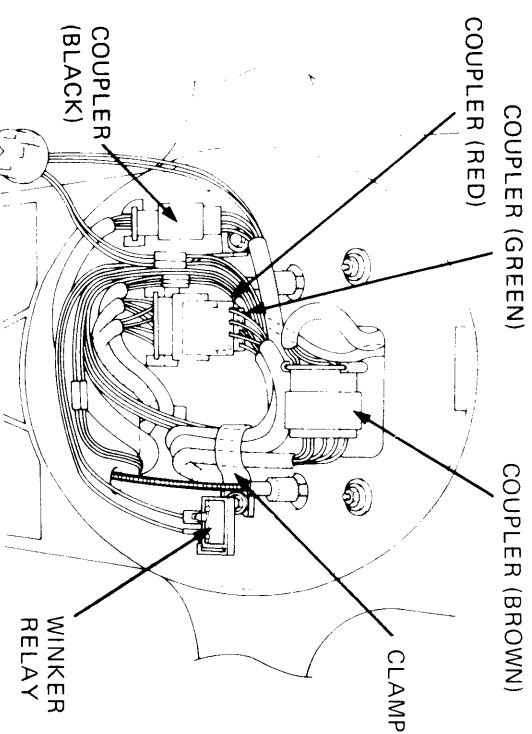
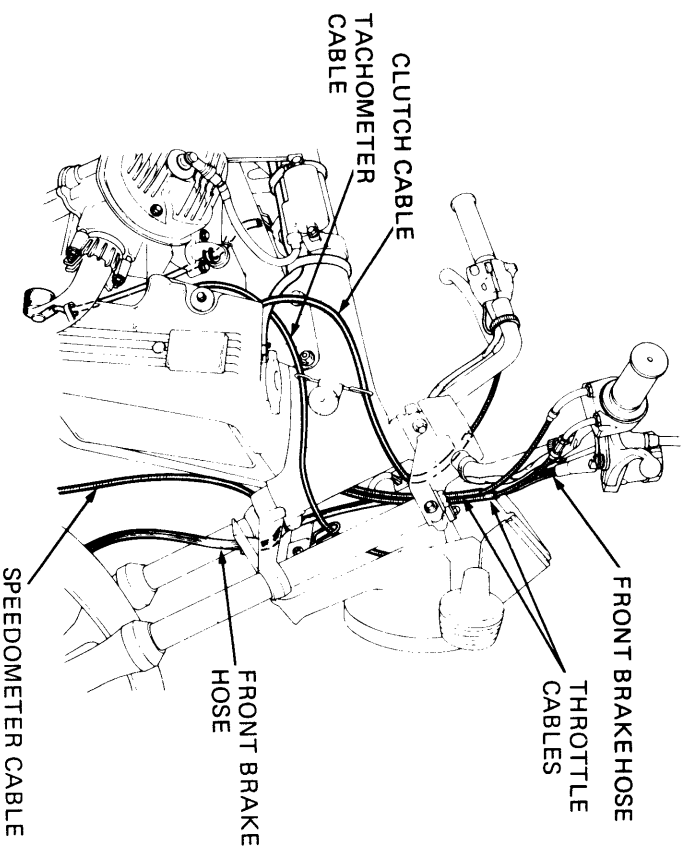
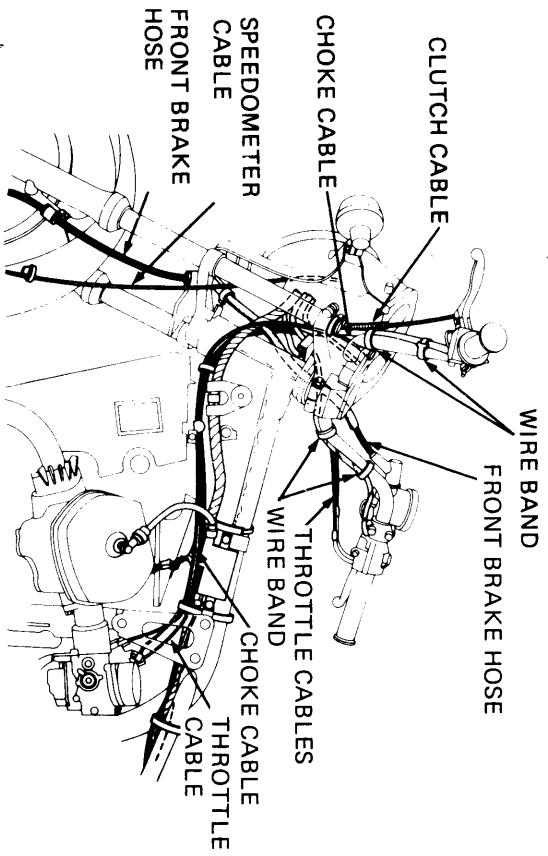
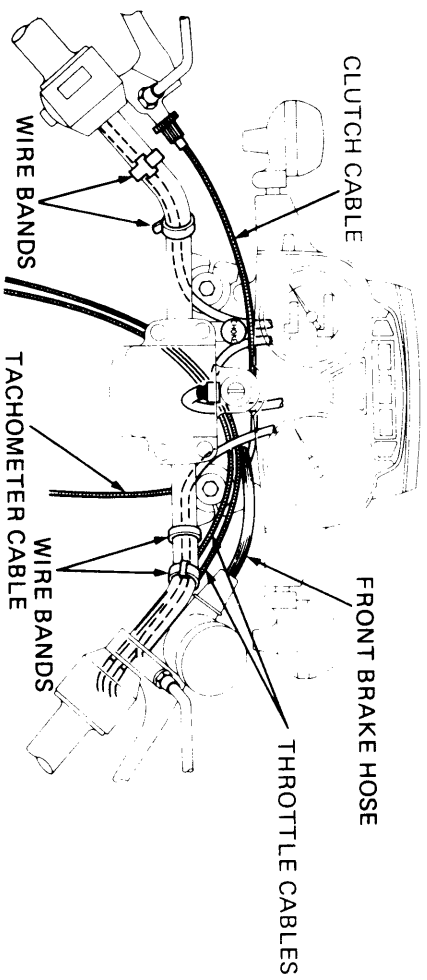



EMISSION CONTROL SYSTEM

The CX500 is equipped with two emission control systems.

- EXHAUST EMISSION CONTROL SYSTEM

The exhaust emission control system is composed of a factory pre-set carburetor. No adjustment should be made except to the idle speed with the throttle stop screw.

- CRANKCASE EMISSION CONTROL SYSTEM

The engine is equipped with a "Closed System" to prevent crankcase emission from entering the atmosphere. Blow-by gas is returned to the combustion chamber through the breather tube, separator and intake pipe.

CRANKCASE EMISSION CONTROL SYSTEM

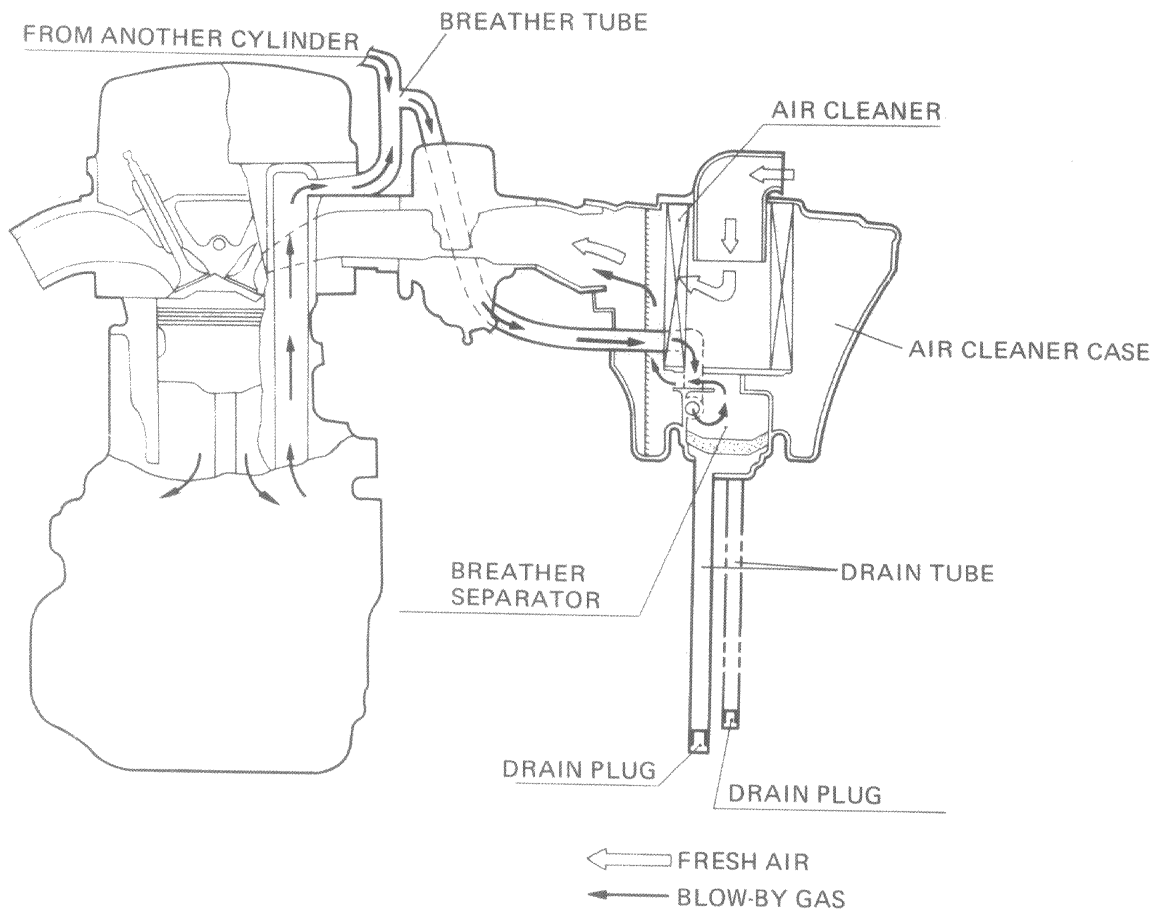

**EMISSION CONTROL INFORMATION LABEL**

CX500's manufactured after December 31, 1977 have an Emission Control Information label on the frame as shown. It contains basic tune-up specifications for CX500's manufactured after December 31, 1977. Refer to this Shop Manual for more details.

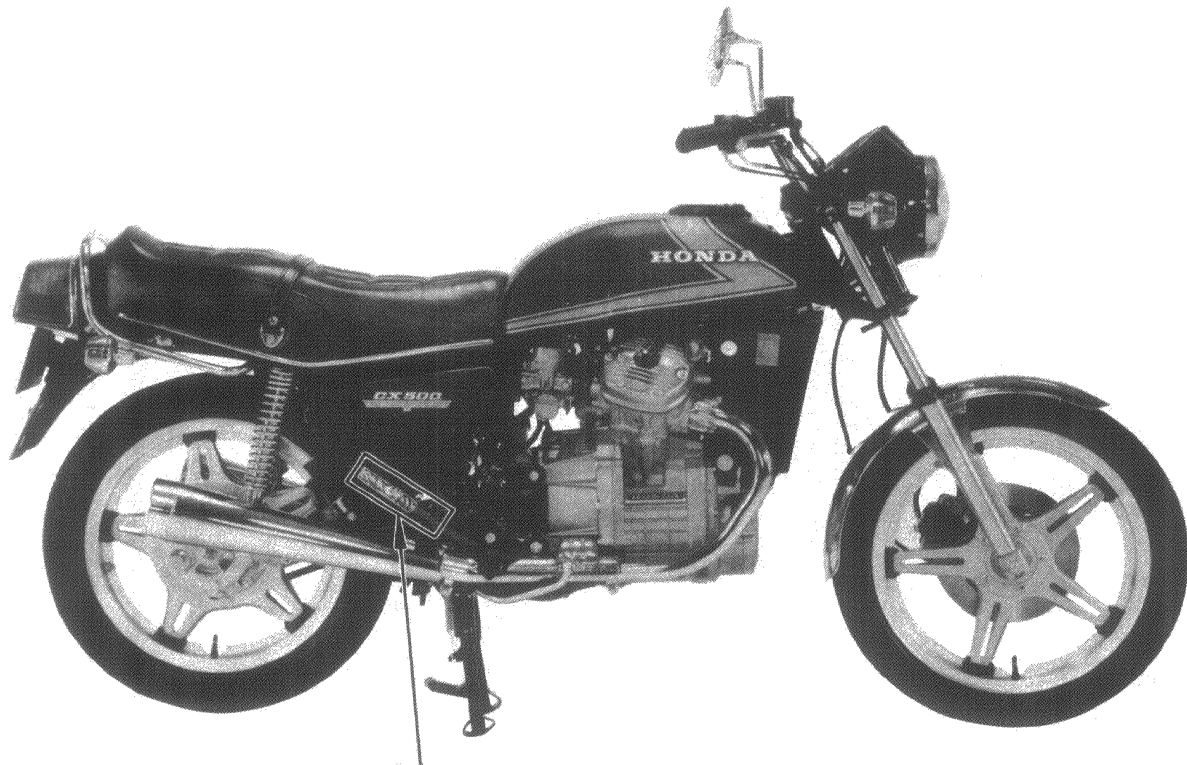

EMISSION CONTROL INFORMATION LABEL



MAINTENANCE SCHEDULE

Perform the PRE-RIDE INSPECTION in the Owner's Manual at every maintenance period.

I : INSPECT, CLEAN, ADJUST, LUBRICATE OR REPLACE IF NECESSARY.

C: CLEAN

R: REPLACE

A: ADJUST

L: LUBRICATE

ITEM	FREQUENCY	WHICHEVER OCCURS FIRST ↓ EVERY	ODOMETER READING [NOTE (3)]							REFER TO
			600 mi. (1,000 km)	3,600 mi. (6,000 km)	7,200 mi. (12,000 km)	10,800 mi. (18,000 km)	14,400 mi. (24,000 km)	18,000 mi. (30,000 km)	21,600 mi. (36,000 km)	
EMISSION RELATED ITEMS	ENGINE OIL	YEAR	R		R		R		R	Page 2- 2
	ENGINE OIL FILTER	YEAR	R		R		R		R	Page 2- 2
	CRANKCASE BREATHER	NOTE (1)		C	C	C	C	C	C	Page 3- 3
	AIR CLEANER	NOTE (2)		C	R	C	R	C	R	Page 3- 2
	* FUEL LINES				I		I		I	Page 3- 3
	SPARK PLUGS			I	R	I	R	I	R	Page 3- 3
	* VALVE CLEARANCE		I	I	I	I	I	I	I	Page 3- 4
	* CAM CHAIN TENSION		A	A	A	A	A	A	A	Page 3- 5
	* THROTTLE OPERATION		I		I		I		I	Page 3- 5
	* CARBURETOR-IDLE SPEED		I	I	I	I	I	I	I	Page 3- 6
	* CARBURETOR-CHOKE				I		I		I	Page 3- 6
	* CARBURETOR-SYNCHRONIZE		I		I		I		I	Page 3- 7
	* COOLANT				I		I		R	Page 3- 8 9- 3
	* COOLING SYSTEM, HOSES		I		I		I		I	Page 3- 8
	* RADIATOR CORE				I		I		I	Page 3- 8
NON-EMISSION RELATED ITEMS	* DRIVE SHAFT JOINT				L		L		L	Page 2- 3
	* FINAL DRIVE LUBRICANT				I		I		R	Page 2- 3
	BATTERY	MONTH	I	I	I	I	I	I	I	Page 3- 9
	BRAKE FLUID (FRONT)	MONTH I 2 YEARS R	I	I	I	I	I	I	*R	Page 3- 9
	BRAKE SHOE/PAD WEAR			I	I	I	I	I	I	Page 3-11
	BRAKE SYSTEM		I		I		I		I	Page 3-11
	* BRAKE LIGHT SWITCH		I		I		I		I	Page 3-12
	* HEADLIGHT AIM		I		I		I		I	Page 3-13
	CLUTCH FREE PLAY		I	I	I	I	I	I	I	Page 3-13
	SIDE STAND				I		I		I	Page 3-14
	* SUSPENSION		I		I		I		I	Page 3-14
	* NUTS, BOLTS, FASTENERS		I		I		I		I	Page 3-15
** WHEELS		I		I		I		I	Page 3-15	
** STEERING HEAD BEARING		I		I		I		I	Page 3-15	

** IN THE INTEREST OF SAFETY, WE RECOMMEND THESE ITEMS BE SERVICED ONLY BY AN AUTHORIZED HONDA DEALER.

* SHOULD BE SERVICED BY AN AUTHORIZED HONDA DEALER, UNLESS THE OWNER HAS PROPER TOOLS AND IS MECHANICALLY QUALIFIED.

NOTES: (1) More frequent service may be required when ridden in rain, ridden at full throttle openings, dropped or washed often.

Service if deposit level can be seen in the transparent section of drain tubes.

(2) More frequent service may be required when riding in dusty areas.

(3) For higher odometer readings, repeat at the frequency interval established here.